



Users Manual

The TimeSaving Loudness Automation Software

DKT7, Version 2015, Release date 2014-10-18

Revision 1.0

Table of Contents

THE TIMESAIVING LOUDNESS AUTOMATION.....	3
BEFORE YOU BEGIN.....	3
ABOUT THIS MANUAL	3
OTHER IMPORTANT NOTES.....	4
OVERVIEW.....	6
UNDERSTANDING THE PROBLEM OF READING THE INTEGRATING LOUDNESS	6
INSTALLING THE LICENSE KEY.....	7
USING THE DEMONSTRATION MODE WITHOUT THE LICENSE KEY.....	7
DESCRIPTION OF FUNCTIONALITY.....	8
INPUT K-FILTER AND RECTIFIER.....	8
CAPTURE PRE-ROLL STATE WITH EXTERNAL SMPTE TIMECODE.....	8
DATABASE.....	8
THE LOUDNESS CALCULATION PART.....	9
THE GRAPHIC DISPLAY.....	9
THE MAIN CONTROL PANEL.....	10
TERMINATING THE TIMESAIVING LOUDNESS AUTOMATION.....	10
CAPTURE MODE SELECTION.....	10
CURSOR SCROLL OPTION.....	10
RESET MEMORY.....	10
RESET MAX VALUES.....	10
THE SETUP FOLDER.....	11
TIME CODE SELECTION.....	11
LOUDNESS PRESET LIST.....	11
LOUDNESS SETUP.....	11
NAVIGATING THE GRAPHIC CAPTURE WINDOW.....	12
ADJUSTING THE OBSERVATION TIME.....	12
SETTING THE OBSERVATION START TIME.....	12
THE LOUDNESS PERFORMANCE BAR.....	12
APPENDIX A.....	15
LIST OF THE R128 LOUDNESS PRESET SETTINGS.....	15
LIST OF THE ATSC LOUDNESS PRESET SETTINGS.....	15
LIST OF THE LEQM LOUDNESS PRESET SETTINGS.....	15

The TimeSaving Loudness Automation

Before you begin...

Thank you for purchasing the TimeSaving Loudness Automation software for the DKT7 family members.

The software package is a standard part of the 2015 version with release date and the 2015 version of the firmware and software support a USB computer mouse. The application package need a activation key which can be obtained from your local dealer or a DK-Technologies sales office. All illustrations are based on operation with a mouse since the display is adaptive to the pointing device used unless noted.

With the DK T7 and this software package you are well equipped to meet the growing challenges within Audio and Loudness metering.

The DK T7 complies with all major Broadcast loudness standards and delivers outstanding metering precision and clear read-outs, not merely on Loudness, but across the full range of audio metering tools.

The DK T7 toolset makes it application-fit for any audio and loudness setup in broadcast, film & post production as well as live transmission and recording. All ITU based standards and LeqM are supported.

With the clear DK T7 readout and compliance in your line of sight, you are always **safe and sound**.

About this manual

This manual will provide you with a quick overview of how to benefit from the advanced function found in the software package.

Please study the general DKT7 operational manual on how to navigate and setup the unit. The manual can be download by following the below link.

Happy reading!

Please note: DK-Technologies reserve the rights to change the content of this manual at any time. The latest revision of this manual can be downloaded from: www.DK-Technologies.com

Email contact: sales@dk-technologies.com

Other Important Notes

Disclaimer

No part of this document may be reproduced or transmitted in any form or by any means, electronic or mechanical, including photocopying and scanning, for any purpose, without the prior written consent of DK-Technologies A/S. The company aims to ensure that all details in this document are correct at the time of publication, but reserves the right to alter specifications and equipment without notice. The latest version will be available upon request. This publication is for international usage.

Despite considerable effort to produce up to date information, no literature published by the company nor any other material that may be provided should be regarded as an infallible guide to the specifications available nor does it constitute an offer for sale of any particular product.

StarFish and JellyFish are registered trademarks of DK-Technologies A/S. Dolby®E is a registered trade mark of Dolby Laboratories, Inc. The ownership of any trademarks referenced is acknowledged.

© 2014 DK-Technologies A/S. E&OE. All Rights Reserved.

Purpose

Any fitness for purpose legislation or other determination that may be applied in the area where this equipment is installed must take due cognizance that it is designed for use in professional broadcast, audio and video systems by appropriately trained personnel. The equipment is not intended for use in a domestic environment and regulations designed for such situations are not applicable.

After sales modifications

Any modifications to the equipment not specifically authorised and approved by DK-Technologies A/S may invalidate the equipment warranty. This includes changes to cabling and variations to the recommended installation as detailed in the documentation issued by DK-Technologies A/S. Modifications can invalidate EMC and safety features designed into this equipment and the manufacturer cannot be liable for any legal proceedings or problems that may arise relating to such modifications. No sales agent or other person involved in the supply chain is permitted to authorise variations from the content of this documentation.

Important Safety Instructions

- ◆ Read these instructions. Study carefully and understand all safety and operating instructions before you install and operate the unit!
- ◆ Keep these instructions. Keep all safety and operating instructions for future reference!
- ◆ Heed all warnings on the unit and in the safety and operating instructions before you install and operate the unit!
- ◆ Follow all instructions to ensure against injury to yourself and damage to the unit or other objects connected to the unit.
- ◆ To prevent possible electrical shock, death, fire, injuries and malfunctions, use this product only as specified.

- ◆ Only use attachments and accessories specified by the manufacturer.
- ◆ The units of the DK Meter range are designed for indoor use only

Overview

Understanding the Problem of Reading the Integrating Loudness

When measuring the integration loudness according to the ITU, EBU R128 or LeqM (Movie) specifications a total score value has to be measured from the start time to the stop time which basically force the sound mixer to re-measure the whole session if a change is made in the middle of the mix.

Furthermore, a change in the middle of the mix also has an influence on the loudness values calculated before and after the changes.

The time saving loudness automation application take care of that problem by means of a database holding the loudness value before and after the changes providing the ability to give an instant loudness score value for the whole session when changes are done in the middle part.

The different operational modes:

- Post Production for audio with the length from 10 seconds to 3 minutes using the internal clock.
- Post Production for audio with the length from 10 seconds to 1 hour having an external SMPTE time code available.
- Broadcast Live production with a historical one hour time-line view with and without external SMPTE time code.

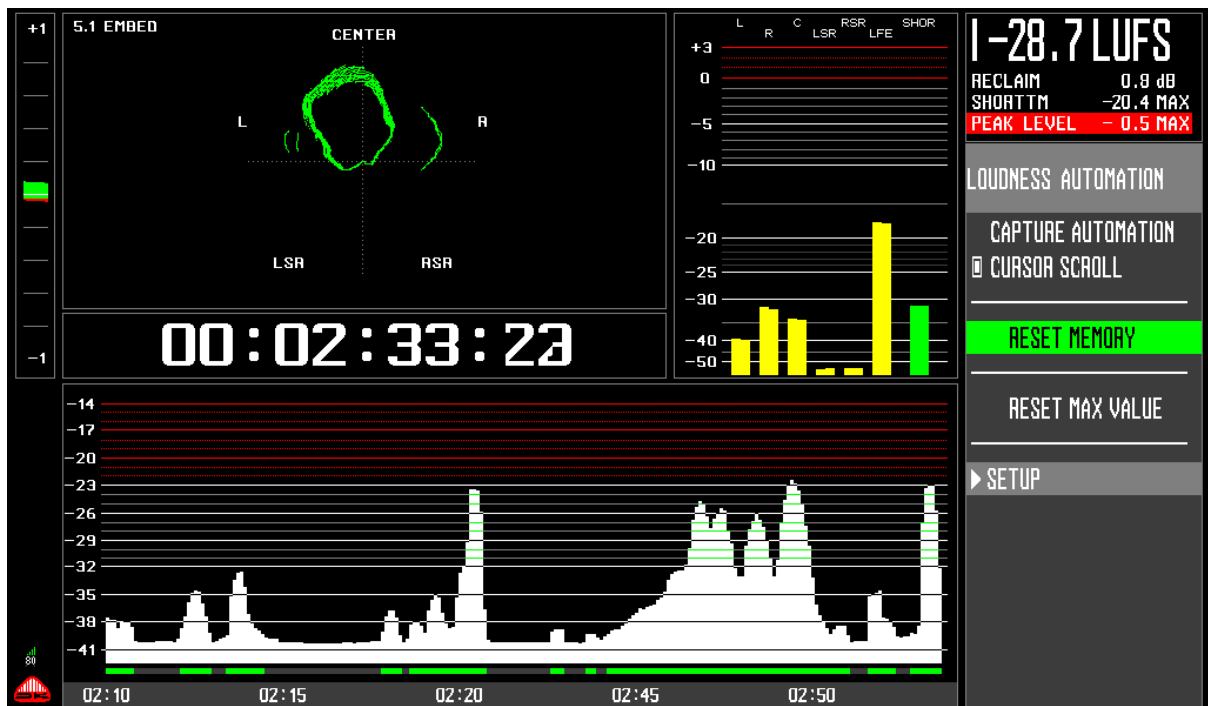

Illustration 1: The DKT7 with TimeSaving Loudness Automation and Starfish 5.1

Installing the License Key



Illustration 2: The License Key Template

The 8 character wide License Key is entered in the **ACTIVATION KEY** folder under **SOFTWARE** folder. Legal characters are 0..9 and A,B,C,D,E and F.

Touch the folder line **AUTOMATION FFFF FFFF** in order to engage the editor. **BACKSPACE** the displayed key and enter 8 characters without spaces , press **SAVE** and **QUIT** and the software is ready to use.

Right click with the mouse on an empty vertical key in order to assign the **AUTOMATION** engage key if needed.

Using the Demonstration Mode without the License Key

When no valid license key is installed the application will work in demonstration mode. In the demonstration mode the time saving loudness automation template is limited to work for approximately 2 minutes. A relative count down is shown below the header.

There is no limitation to the functionality and the number of times the demonstration mode can be engaged.

Sales Part no: **DK T7 AUTOMATION LICENSE**

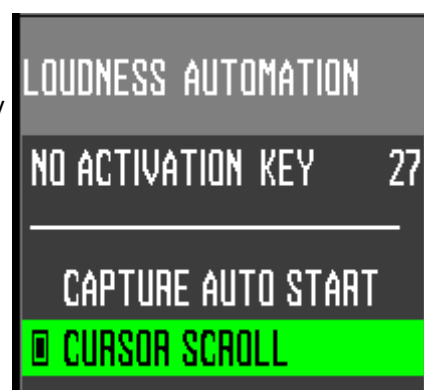
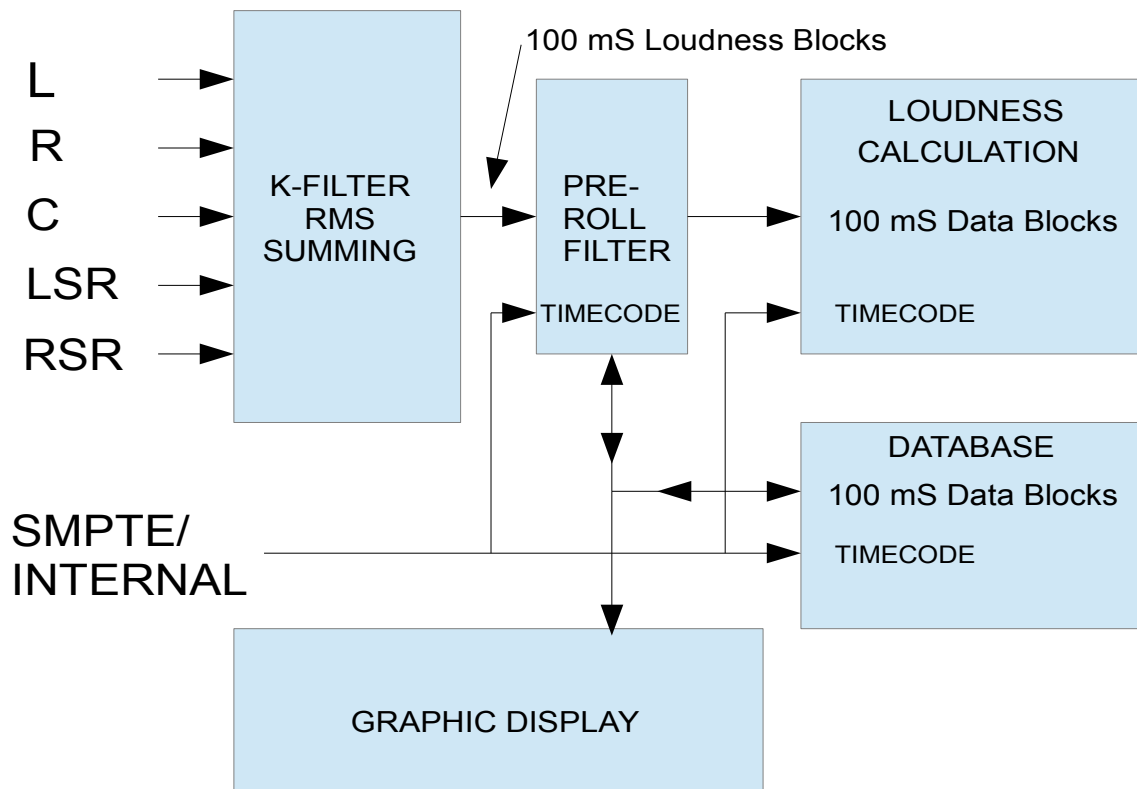

Illustration 3: Demo Count Down

Description of Functionality



Input K-Filter and Rectifier

The input signals are filtered, rectified and summed in the input block according to the ITU or LeqM specifications. The output from the input section is a data stream with the loudness values packed into 100 ms blocks. These blocks are the input signal to the pre-roll filter. When using the internal generated timecode the pre-roll filter is by-passed.

Capture pre-roll State with External SMPTE Timecode

The pre-roll filter will read or write data to the capture database depending on its state of operation. The pre-roll is defined to 3 seconds and will always be active after the external SMPTE timecode has been halted or shifted to an earlier timecode. The pre-roll is required for the synchronisation of the different clock domains.

Database

A database is used to store the 100 ms loudness blocks indexed to the timecode and the storage capacity has been limited to one hour. In the capture mode automation the recording will stop and in all other modes the oldest data will be overwritten permitting a one hour historical view.

The Loudness Calculation Part

From the 100 ms blocks the Integrating, Momentary and Short Terms loudness values are calculated based on the values stored in the database or incoming data stream. The method applied depends on the specification selected.

The Graphic Display

The graphic display has interface to the captured values in the database and is only used to inspect the data. Different use of the screens has no impact on the actual data capture since the application is separated from the capture engine.

The Main Control Panel

Please study the above section *Description of the Functionality* for the detailed explanation of the of the below functions.

Terminating the TimeSaving Loudness Automation

The graphic display is terminated by pressing the header field.

Capture Mode Selection

Activate the CAPTURE line by touching the screen or use the left mouse left. Use the mouse wheel to roll between CAPTURE AUTO START, CAPTURE START PAUSE or CAPTURE AUTOMATION. The invisible scroll bar on the touch screen right hand side will also roll the selection items.

Cursor Scroll Option

The CURSOR SCROLL option is toggled by touching the line or a left mouse click. The function is similar to touching the center of the graphic display explained in the section *Changing the Cursor Scroll Mode*.

Reset Memory

The loudness automation software is using a database to store the recorded data. This data must be erased as the first thing to do when a new session is started. Pressing the RESET MEMORY will clear all recorded data and the maximum readings. The user will be asked to confirm the memory reset since there is no undo memory clear.

Reset Max Values

The RESET MAX VALUE is used to reset the temporary memory cells holding the maximum readings since last reset. It is not affecting the loudness capture and can be engaged at any time during a session

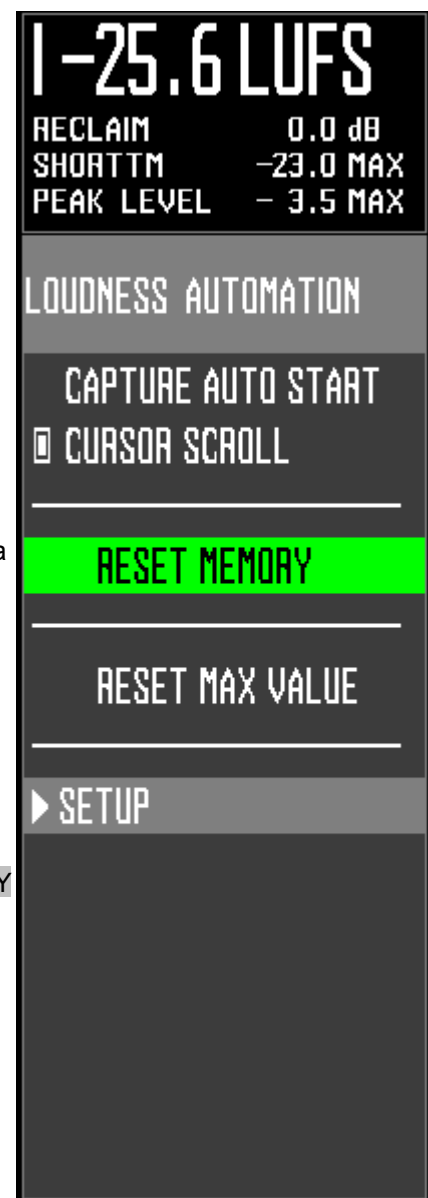

Illustration 4: Main Control Panel

The Setup Folder

Time Code Selection

The application can log the capture in respect to an INTERNAL TIME generated time code that is reset to zero when the reset function is engaged. The SMPTE DECODER selection will engage a decoder that will interpretate an analogue provided time code provided to the analogue inputs.

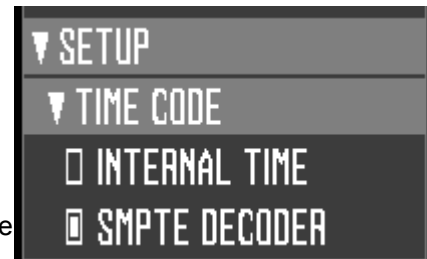

Illustration 5: Time Code Source

Loudness Preset List

The software is preconfigured with a set of common LOUDNESS PRESETS in order to setup the loudness reading and capture to a unified set of settings. If the standard selection list is inadequate it is possible to select the USER and adjust the loudness reading parameters individual. The predefined loudness presets will be update from time to time and is not a part of the application software itself. Appendix A provide a list of common presets.



Illustration 6: Loudness Preset List

Loudness Setup

Touch the parameter you want to change and use the scroll bar or the mouse wheel to alter the parameter. The choices are listed below.

FILTER OFF, FILTER K-FILTER, FILTER LEQM
SCALE MODE LU, SCALE MODE LUFs, SCALE MODE LKFS
SHORTTM WINDOW, MOMENTARY, 3 SEC, 10 SEC, 30 SEC
REFERENCE between -9 dBFS and -24 dBFS
PEAK LEVEL between -1 dBFS and -10 dBFS
GATE LEVEL between -8 dB and -20 dB (no gate)
PEAK MODE TRUE PEAK, PEAK MODE DIGITAL PEAK
REFERENCE 400 Hz, REFERENCE 1000 Hz

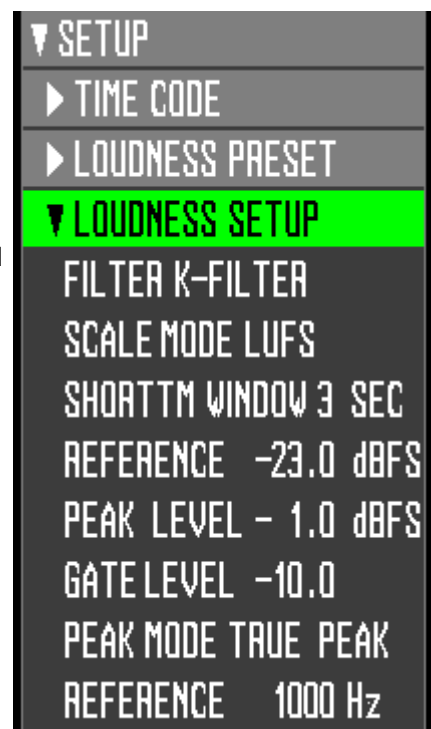

Illustration 7: Loudness Setup Parameters Example

Navigating the Graphic Capture Window

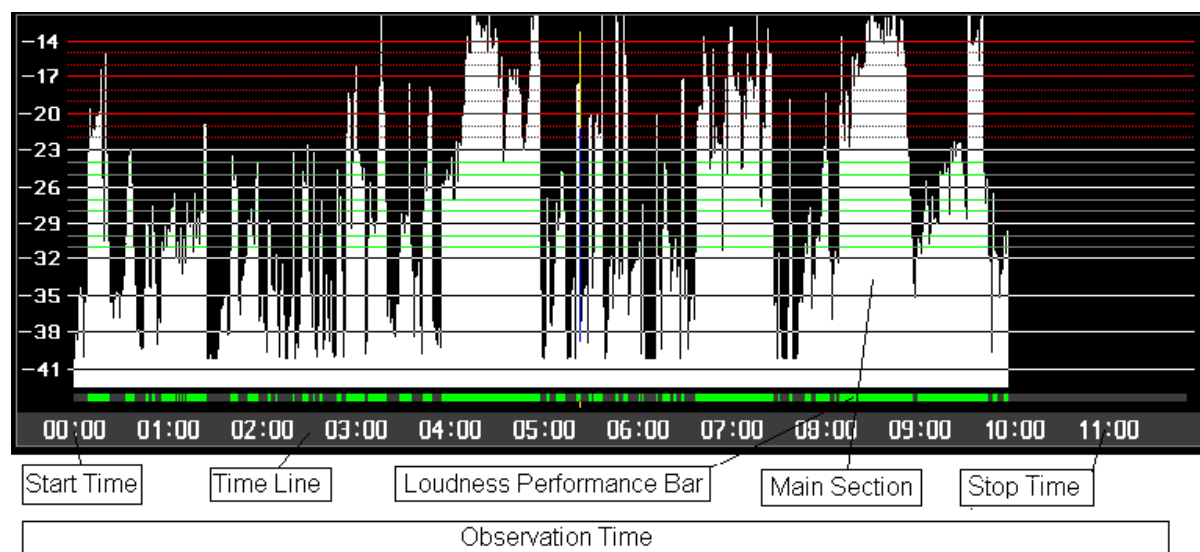

Illustration 8: The Graphic Capture Window Layout

Adjusting the Observation Time

Touch and hold your finger on the Time Line and slide horizontal in order to change the Observation Time. Sliding from right to left will increase the viewing time. With the mouse, put the pointer in the Time Line and use the wheel to adjust the viewing time.

Setting the Observation Start Time

The Start Time is frozen when the when the Main Section of the screen is touched. Moving the finger horizontal will slide the observation window and move the cursor to the left side of the screen. The cursor is released by touching the screen again or touching the CURSOR SCROLL line in the main control panel.

Placing the mouse pointer in the main section and using the mouse wheel will slide the observation time. The cursor is released with a mouse click.

The Loudness Performance Bar

When using gating low level captured value are excluded from the loudness calculation and the number of loudness samples contributing to calculation is reduced effectively giving a higher loudness score. The dark grey zones on the loudness performance bar demonstrates this behaviour.

The DKT7 also provide you with a numerical readout of the lost loudness named the RECLAIM value. The above graph has a reclaim value of 2.8 dB which represent the total score or energi in the grey zones. **Changing the mix by raising the level in the grey zones will lower the total integrating loudness value** and in the above example 2.8 dB without changing the total overall gain.

Illustration Index

Illustration 1: The DKT7 with TimeSaving Loudness Automation and Starfish 5.1.....	6
Illustration 2: The License Key Template.....	7
Illustration 3: Demo Count Down.....	7
Illustration 4: Main Control Panel.....	10
Illustration 5: Time Code Source.....	11
Illustration 6: Loudness Preset List.....	11
Illustration 7: Loudness Setup Parameters Example.....	11
Illustration 8: The Graphic Capture Window Layout.....	12

Alphabetical Index

10 SEC.....	11
1000 Hz.....	11
3 SEC.....	11
30 SEC.....	11
400 Hz.....	11
activation key.....	3
CAPTURE AUTO START.....	10
CAPTURE AUTOMATION.....	10
CAPTURE START PAUSE.....	10
Cursor Scroll.....	10
CURSOR SCROLL.....	10, 12
DIGITAL PEAK.....	11
Email contact.....	3
FILTER K-FILTER.....	11
FILTER LEQM.....	11
FILTER OFF.....	11
GATE LEVEL.....	11
INTERNAL TIME.....	11
LOUDNESS PRESETS.....	11

MOMENTARY.....	11
Observation Time.....	12
PEAK LEVEL.....	11
PEAK MODE.....	11
reference.....	4
REFERENCE.....	11
RESET MAX VALUE.....	10
RESET MEMORY.....	10
Sales Part no.....	7
SCALE MODE LKFS.....	11
SCALE MODE LU.....	11
SCALE MODE LUFs.....	11
SHORTTM WINDOW.....	11
SMPTE DECODER.....	11
Start Time.....	12
Time Line	12
TRUE PEAK.....	11
USER.....	11
ACTIVATION KEY.....	7

Appendix A

List of the R128 Loudness Preset Settings

```
FILTER K-FILTER  
SCALE MODE LUFS  
SHORTTM WINDOW 3 SEC  
REFERENCE -23.0 dBFS  
PEAK LEVEL - 1.0 dBFS  
GATE LEVEL -10.0  
PEAK MODE TRUE PEAK  
REFERENCE 1000 Hz
```

List of the ATSC Loudness Preset Settings

```
FILTER K-FILTER  
SCALE MODE LKFS  
SHORTTM WINDOW 10 SEC  
REFERENCE -24.0 dBFS  
PEAK LEVEL - 2.0 dBFS  
GATE LEVEL -20.0  
PEAK MODE TRUE PEAK  
REFERENCE 1000 Hz
```

List of the LEQM Loudness Preset Settings

```
FILTER LEQM  
SCALE MODE LUFS  
SHORTTM WINDOW 3 SEC  
REFERENCE -20.0 dBFS  
PEAK LEVEL - 6.0 dBFS  
GATE LEVEL -20.0  
PEAK MODE TRUE PEAK  
REFERENCE 1000 Hz
```